

ASSEMBLY INSTRUCTION
ITEM CODE - VI-DT55
INDUSTRIAL OVAL DINNING TABLE

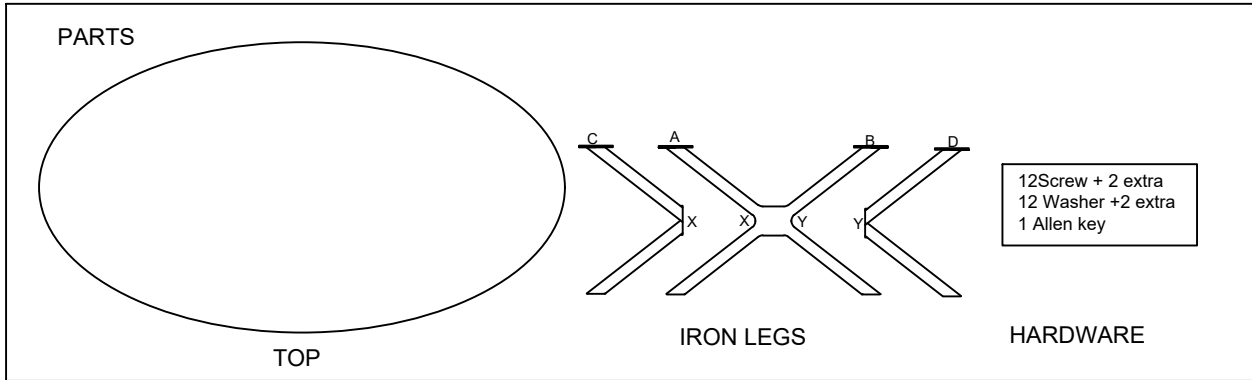

STEP-1
 *PLACE TOP UPSIDE DOWN

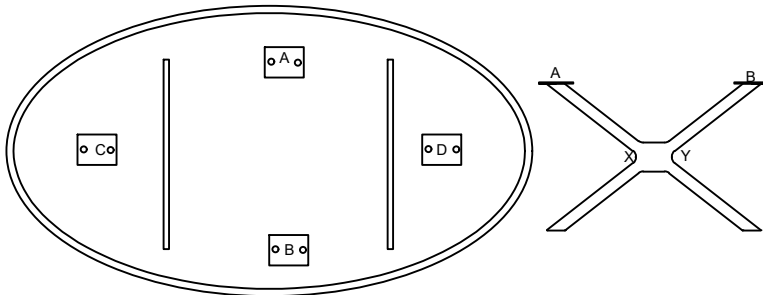

STEP-2
 *Screw leg A to A & B to B

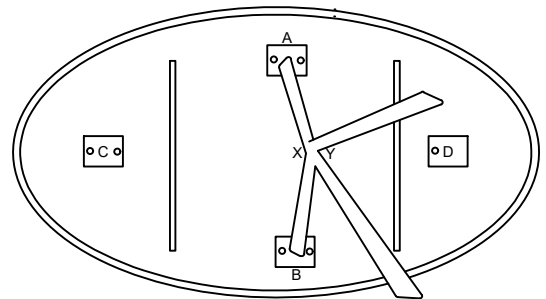

STEP-3
 *Place leg C & D

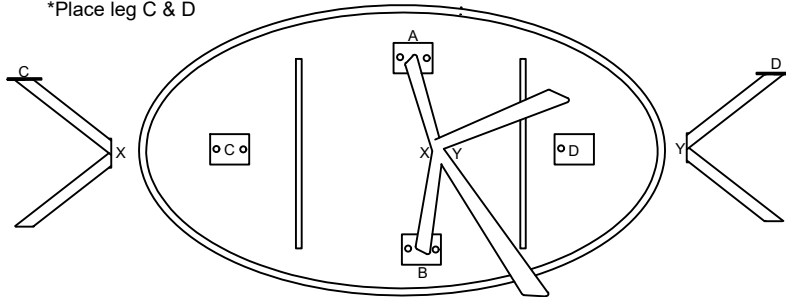

STEP-4
 *Screw leg C to C & X to X

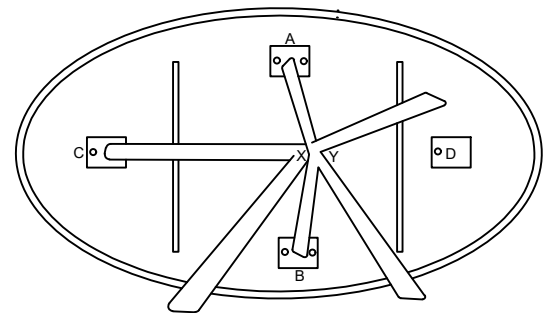

STEP-5
 *Screw leg D to D & Y to Y

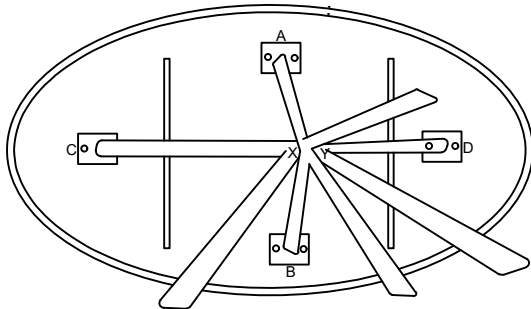

STEP-6

